



DSEControl



# DEEP SEA ELECTRONICS

## DSEServiceTool

### PC Software Manual

Document Number: 057-265

Author: Tony Manton



Deep Sea Electronics Ltd  
Highfield House  
Hunmanby  
North Yorkshire  
YO14 0PH  
ENGLAND

Sales Tel: +44 (0) 1723 890099  
Sales Fax: +44 (0) 1723 893303

E-mail: sales@deepseaelectronics.com  
Website: www.deepseaelectronics.com

### DSEServiceTool PC Software Manual

© Deep Sea Electronics Ltd

All rights reserved. No part of this publication may be reproduced in any material form (including photocopying or storing in any medium by electronic means or other) without the written permission of the copyright holder except in accordance with the provisions of the Copyright, Designs and Patents Act 1988.

Applications for the copyright holder's written permission to reproduce any part of this publication must be addressed to Deep Sea Electronics Ltd at the address above.

The DSE logo and the names DSEGenSet, DSEATS, DSEPower and DSEControl are UK registered trademarks of Deep Sea Electronics Ltd.

Any reference to trademarked product names used within this publication is owned by their respective companies.

Deep Sea Electronics Ltd reserves the right to change the contents of this document without prior notice.

#### Revision History

Issue No.	Comments
1	First Issue.
2	Updated to include support for DSEM840 and DSEM870.
3	Added full M870 file transfer support and more details throughout.
4	Added support for DSEM643 and DSEM240.
5	Added support for DSEM835
5.1	Added note to stop gateway for M835.
6	Added DSEM812
7	Added CAN support to M640 / M643
8	Added support for DSEM871. Minor note changes. Added more information to <i>Searching for Devices</i> section.
9	Added DSEM835 Batch Programming instructions for DSEM835 Bootloader V1.1.0+ and DSEServiceTool V1.46.3+
10	Added DSEM835 baud rate (Section 4.3) Added Command Line conversion details (section 5)

## TABLE OF CONTENTS

Section	Page
<b>1 INTRODUCTION .....</b>	<b>4</b>
1.1 CLARIFICATION OF NOTATION.....	4
1.2 GLOSSARY OF TERMS.....	4
1.3 BIBLIOGRAPHY .....	5
<b>2 INSTALLATION.....</b>	<b>6</b>
2.1 INSTALL THE PCAN DRIVER .....	6
2.2 SOFTWARE INSTALLATION .....	6
2.2.1 MINIMUM SYSTEM REQUIREMENTS .....	6
2.2.2 INSTALLATION OF DSESERVICETOOL PC SOFTWARE .....	6
<b>3 USB-CAN INTERFACE .....</b>	<b>8</b>
3.1 BATCH PROGRAMMING CONNECTIONS FOR DSEM835 .....	9
3.1.1 TYPICAL CONNECTION DIAGRAM .....	10
3.1.1.1 EXAMPLE WITH ONLY TWO DEVICES CONNECTED TO THE TEN WAY HARNESS 10	
3.1.2 PARTS LIST.....	11
<b>4 USING DSESERVICETOOL PC SOFTWARE .....</b>	<b>12</b>
4.1 STARTING DSESERVICETOOL SOFTWARE .....	12
4.2 PREPARING THE DEVICE FOR CONNECTION .....	12
4.2.1 BOOTLOADER MODE.....	12
4.2.2 DSEM240 .....	13
4.2.3 DSEM640 & DSEM643 .....	13
4.2.4 DSEM835 .....	14
4.2.4.1 CONNECTION FROM PC TO A SINGLE DSEM835 DEVICE .....	14
4.2.4.2 CONNECTION FROM PC TO MULTIPLE DSEM835 DEVICES .....	15
4.2.5 DSEM840 .....	16
4.2.6 DSEM870 / DSEM871 .....	17
4.2.7 DSEM812 .....	18
4.3 SEARCHING FOR DEVICES .....	19
4.3.1 FAILED TO INITIALISE CAN .....	20
4.3.2 NO MODULES FOUND .....	20
4.3.3 DEVICES FOUND .....	21
4.3.3.1 CAN CONNECTED DEVICES .....	21
4.3.3.2 ETHERNET CONNECTED DEVICES .....	21
4.4 BASIC.....	22
4.4.1 DSEM240 .....	22
4.4.2 DSEM640, DSEM643, DSEM840, DSEM870, DSEM871, & DSEM812 .....	23
4.4.3 DSEM835 .....	24
4.4.4 PARAMETERS .....	24
4.5 ADVANCED .....	26
4.5.1 PARAMETERS .....	26
4.6 MODULE INFORMATION .....	29
4.7 ABOUT.....	29
<b>5 COMMAND LINE CONTROL OF DSESERVICETOOL PC SOFTWARE .....</b>	<b>30</b>
5.1 SUMMARY .....	30
5.2 CREATION OF BOOT APPLICATION .....	30
5.3 CONVERSION OF .APP TO .PKG .....	31
5.4 ETHERNET TRANSFER OF THE .PKG FILE TO THE TARGET DEVICE .....	32

# 1 INTRODUCTION



DSEServiceTool is used to scan local networks (LAN or CAN) connected to the PC for supported devices manufactured by Deep Sea Electronics Ltd.

DSEServiceTool lists the devices found, displaying available network connection information. This is used to update the firmware and download a program to the device.

For DSEM835 with serial number 8958811 onwards, and DSEServiceTool V1.46.3 onwards, batch programming of up to ten (10) devices is available. See section entitled *Batch Programming Connections for DSEM835* elsewhere in this document.

## 1.1 CLARIFICATION OF NOTATION

*Clarification of notation used within this publication.*

 <b>NOTE:</b>	Highlights an essential element of a procedure to ensure correctness.
 <b>CAUTION!</b>	Indicates a procedure or practice, which, if not strictly observed, could result in damage or destruction of equipment.
 <b>WARNING!</b>	Indicates a procedure or practice, which could result in injury to personnel or loss of life if not followed correctly.

## 1.2 GLOSSARY OF TERMS

Used to list acronyms, abbreviations etc used within the document.

Term	Description
Application	Generally produced by the OEM or DSE customer, this code is created using CODESYS.
Bootloader	Software within the MSeries device that is executed at device power up. Used to detection connection to DSEServiceTool and handle the update process.
CAN	Controller Area Network. Requires to the use of a Peak PCAN interface as detailed in the sections entitled <i>DSEM240</i> and <i>DSEM835</i> elsewhere in this document.
DSEServiceTool	Short name for DSEServiceTool PC Software.
Firmware	Software within the MSeries that handles the execution of the application code.
IP	Internet Protocol Commonly used when describing the ethernet network address of a device (IP Address).
LAN	Local Area Network (Ethernet).
MAC	Media Access Control. A MAC address is a unique identifier code for a network adaptor connected to a LAN or WAN. The MAC is also used to identify the manufacturer of the device.
PCAN	PCAN USB interface for PC. Manufactured by and copyright / trademark of PEAK-System Technik GmbH · Germany. <a href="https://www.peak-system.com/">https://www.peak-system.com/</a> Provides a CAN interface to USB enabled PCs. This is used by DSEServiceTool to make connection to support CAN enabled M-Series devices.
UID	Unique Identifier. A unique number assigned to each DSE MSeries device.
WAN	Wide Area Network. Usually refers to the World Wide Web of interconnected networks.

### 1.3 BIBLIOGRAPHY

The following documents are available on the DSE website [www.deepseaelectronics.com](http://www.deepseaelectronics.com). These documents refer to DSE controllers supported by DSEServiceTool PC Software.

<b>DSE Part Number</b>	<b>Description</b>
057-270	DSEM240 Operator Manual
057-244	DSEM640 / DSEM643 Operator Manual
057-313	DSEM835 Operator Manual
057-248	DSEM840 Operator Manual
057-246	DSEM870 / DSEM871 Operator Manual
057-320	DSEM870 / DSEM871 CODESYS PC Software Manual
057-317	DSEM812 Operator Manual
057-318	DSEM812 CODESYS PC Software Manual

## 2 INSTALLATION

### 2.1 INSTALL THE PCAN DRIVER

You must install the PCAN Driver supplied with the PCAN Interface, or downloaded from <https://www.peak-system.com/>



This is required to allow DSEServiceTool PC Software to communicate with the PCAN USB device.

This driver must be installed before starting DSEServiceTool PC Software. However it can be installed either before or after the installation of DSEServiceTool PC Software.

### 2.2 SOFTWARE INSTALLATION

#### 2.2.1 MINIMUM SYSTEM REQUIREMENTS

Operating System	Windows 10, Windows 8.1 (Linux support is not provided).
Monitor	17 inch recommended (1024 x 768 resolution)
Communications	Ethernet connection (wired or wireless), PCAN USB interface for CAN supported CAN enabled devices.

<p> <b>NOTE:</b> As DSEServiceTool is a 32 or 64 bit application requiring Microsoft .Net 4.6 framework, it does not operate on Windows 2.0, 3.0, 3.1,3.11, 95, 98, Me, or XP.</p> <p> <b>NOTE:</b> Exit all other programs before installing the software. It is recommended that any earlier releases of the software be uninstalled prior to installing this version.</p> <p> <b>NOTE:</b> Register online at <a href="http://www.deepseaelectronics.com">www.deepseaelectronics.com</a>. Once registered you are able to download updates to the software to ensure that you always have access to the latest features.</p>
---

#### 2.2.2 INSTALLATION OF DSESERVICETOOL PC SOFTWARE

Download the DSEServiceTool PC software installer by visiting [www.deepseaelectronics.com](http://www.deepseaelectronics.com)

Once downloaded, **double-click** the file:

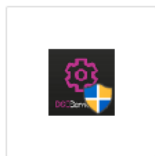

Setup for  
DSEServiceTool.exe

Continued overleaf...

## Installation

The computer prompts for selection of where DSEServiceTool is to be installed on the PC.

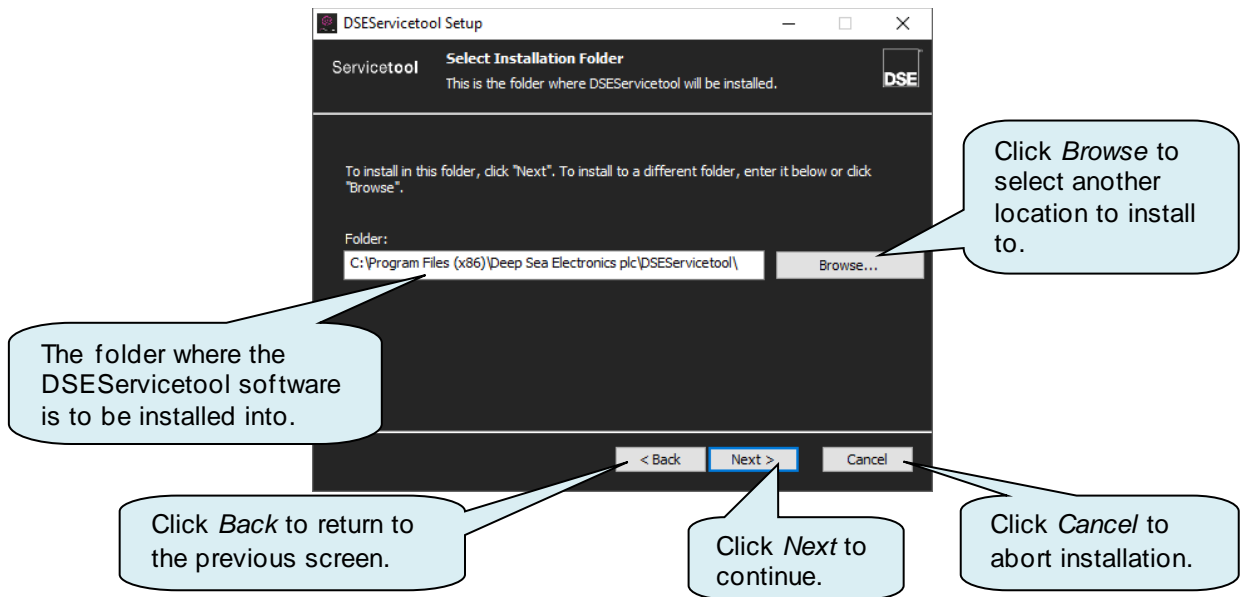

Folder selection has been made and installation is ready to proceed:

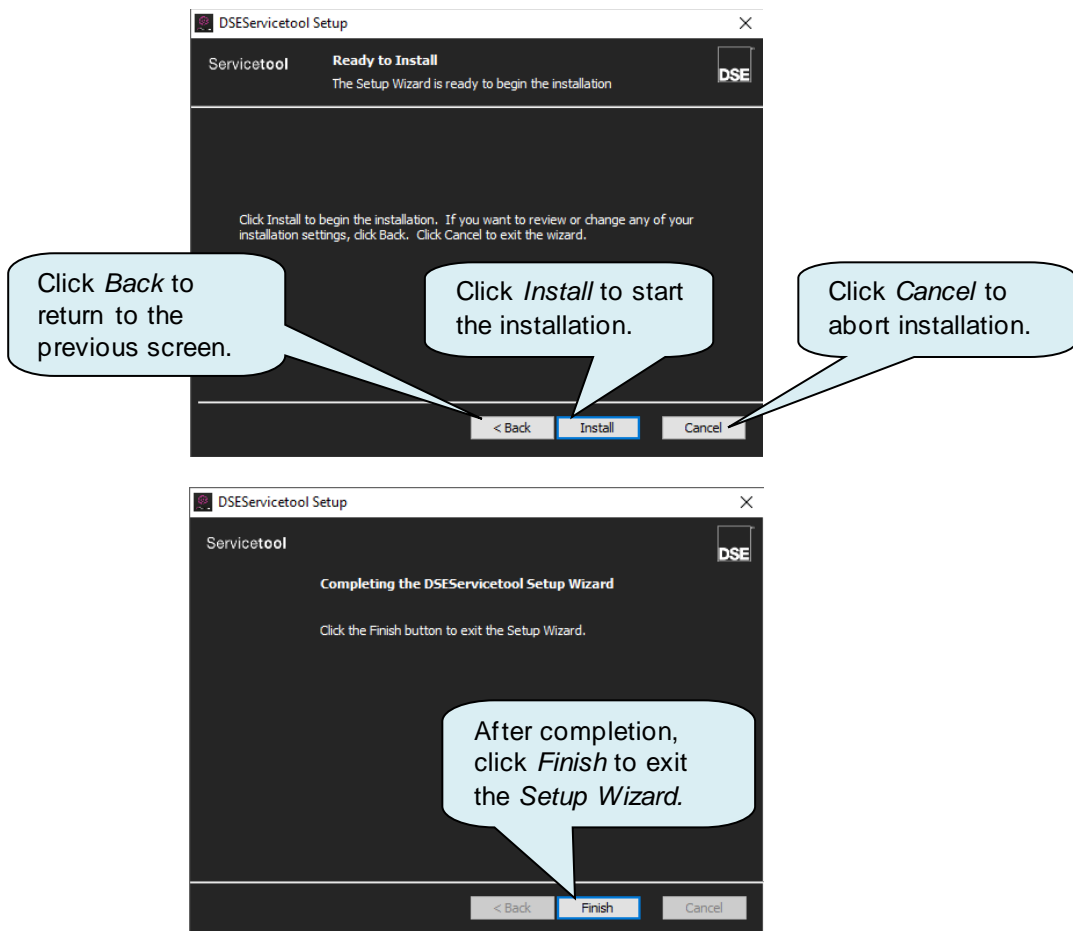

### 3 USB-CAN INTERFACE

**NOTE:** DSE Stock and supply PCAN-USB IPEH-002021. DSE Part number 016-179. Contact sales@deepseaelectronics.com.

**NOTE:** Ensure the PCAN USB driver is installed. For details, see section entitled *Install the PCAN Driver* elsewhere in this document.

**NOTE:** DSEM640 / DSEM643 Connection by CAN is supported from V2.0 onwards.

**NOTE:** DSEM835 supports batch programming from Vx.y onwards. DSEServiceTool V1.46.3 or later is required

DSEM240, DSEM640, DSEM643 and DSEM835 support connection by CAN.

To convert PC USB to CAN Interface, use one of the following devices. Both devices offer the same basic functionality, with the *Opto-Isolated* variant providing enhanced protection should there be a potential difference (up to 500 V) between the Earth points of the CAN device and the PC. The device driver is supplied with the interface and is further available at the website listed in the table below.

Manufacturer	Part Number	DSE Part Number	Description
PEAK-System Technik GmbH <a href="https://www.peak-system.com/">https://www.peak-system.com/</a>	IPEH-002021	016-179	PCAN-USB
	IPEH-002022	N/A	PCAN-USB Opto-Isolated

#### PCAN-USB Connection Details

Connect PCAN-USB to DSEMSeries device using connections for CAN H, CAN L and GND.

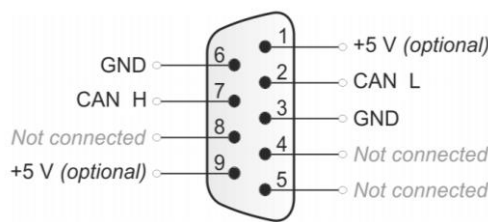

For programming a single DSEM835 connection looms are available from DSE, see DSE Publication 057-313 *DSEEM835 Operator Manual*.

For DSEM835 Batch Programming connections see the following section of this document *Batch Programming Connections for DSEM835* for details how to build your own Batch Programming Loom for use in the production environment.





### 3.1 BATCH PROGRAMMING CONNECTIONS FOR DSEM835

 **NOTE:** Batch programming feature is available only for DSEM835 with Bootloader V1.1.0 onwards. Devices with earlier Bootloader versions cannot be field updated to a later Bootloader version. DSEServiceTool V1.46.3 or later is required. DSEM835 devices with serial number 8958811 and higher are capable of being batch programmed.

 **NOTE:** Batch programming loom is not supplied by DSE.

 **NOTE:** Batch Programming connection length must be as short as possible to meet the needs of the production environment. Absolute Maximum Overall Length of the CAN connection is 40 m (43.7 yards). Excessive length slows transmission and causes transmission failure.

 **NOTE:** Screened 120  $\Omega$  impedance cable specified for use with CAN must be used for the CAN links.  
DSE stock and supply Belden cable 9841 which is a high quality 120  $\Omega$  impedance cable suitable for CAN use (DSE part number 016-030).

 **NOTE:** CAN connections are NOT internally terminated. A complete CAN network must have 120  $\Omega$  terminators at each end of the network.

### 3.1.1 TYPICAL CONNECTION DIAGRAM

**NOTE:** Where less than 10 devices are connected to the loom, remember to add the termination resistor to Pins A3 and A4 of the first unused plug !  
 Additionally, as the loom relies on the M835 internal connection from A3 to A9 and A4 to A10, the plug closest to the 9-way connector **MUST** be used for device 1, then there must be no unconnected plugs between first and last used plug in the loom.

For batch programming up to ten (10) devices are supported. Connections are as follows.

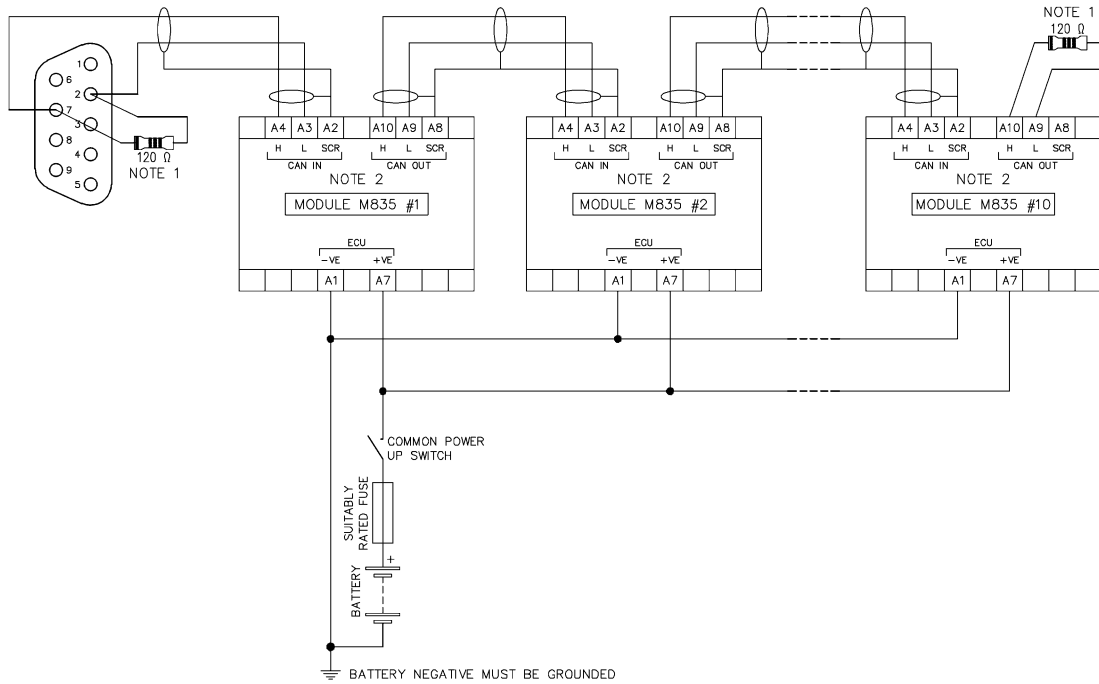

NOTE 1. 120 Ω TERMINATING RESISTORS ARE REQUIRED EXTERNALLY TO THE M835 MODULES  
 NOTE 2. CAN IN AND CAN OUT ARE LINKED INTERNALLY.

#### 3.1.1.1 EXAMPLE WITH ONLY TWO DEVICES CONNECTED TO THE TEN WAY HARNESS

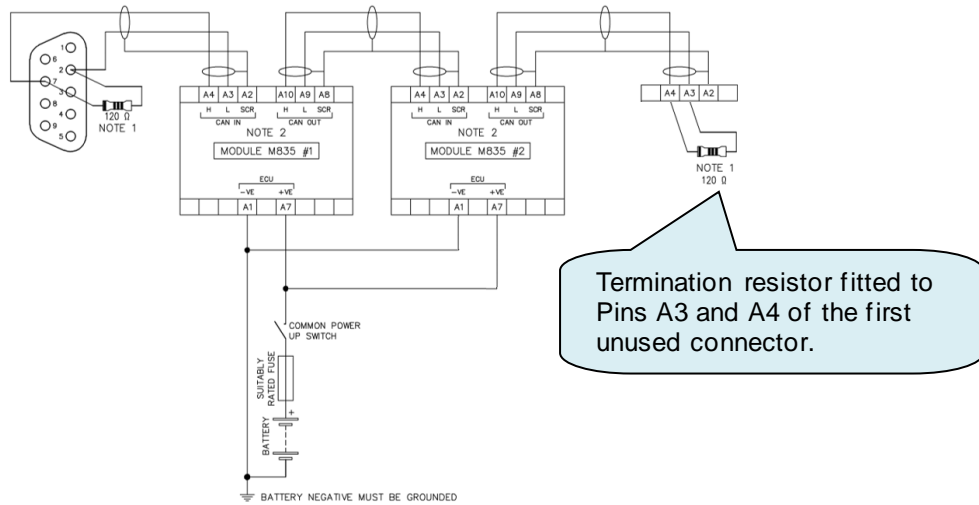

NOTE 1. 120 Ω TERMINATING RESISTORS ARE REQUIRED EXTERNALLY TO THE M835 MODULES  
 NOTE 2. CAN IN AND CAN OUT ARE LINKED INTERNALLY.

**3.1.2 PARTS LIST**

<b>Description</b>	<b>Qty</b>	<b>DSE Part</b>	<b>Manufacturer Part</b>	<b>Manufacturer</b>
DSEM835 Connector A	10	007-850	DT16-18SA-K004	TE / Deutsch
Connector Pin Crimp (0.5 mm <sup>2</sup> to 1.0 mm <sup>2</sup> )	80	N/A	0462-201-16	TE
Belden 9841 (CAN Cable)	As short as possible, absolute Max 40m	016-030	9841	Belden
PCAN-USB PC Configuration Interface	1	016-179	IPEH-002021 or IPEH-002022	PEAK-System Technik GmbH
DE-09 9 way D connector with female pin contacts	1	N/A	Misc	Misc

## 4 USING DSESERVICETOOL PC SOFTWARE

**NOTE:** Ensure the PCAN USB driver is already installed before proceeding. For details, see section entitled *Install the PCAN Driver* elsewhere in this document.

### 4.1 STARTING DSESERVICETOOL SOFTWARE

**NOTE:** Depending upon system settings, Firewall may not automatically begin the Security Alert / access Wizard. You may need to manually add *DSE Module Handler.exe* to the Windows Defender / Firewall exception list.

The loading process takes a few seconds:

When launching the DSEServiceTool PC software for the first time, the PC firewall requires permissions for the software to access the ethernet networks. Permissions are required for the DSEServiceTool to be able to scan the networks and connect to DSEControl devices. Select the type of networks applicable:

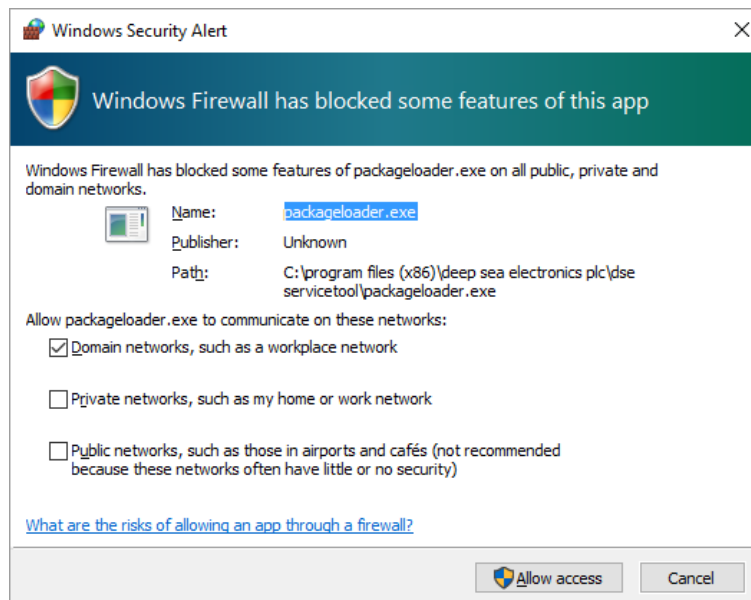

### 4.2 PREPARING THE DEVICE FOR CONNECTION

First ensure the device is correctly connected and in *Bootloader Mode*. This is the state that enables detection of the device by DSEServiceTool Software and allows the transfer of files to the device.

#### 4.2.1 BOOTLOADER MODE

**NOTE:** Ensure the DSEMxxx device is correctly connected and in the bootloader mode during discovery. Devices not in bootloader mode are not discovered by the scan.

Upon loading, the DSEServiceTool automatically performs a search and finds connected devices.

#### 4.2.2 DSEM240

 **NOTE: DSEM240 is no longer available and is included for legacy support only.**

 **NOTE: Ensure no other devices are connected to the CAN during DSEServiceTool operation. This ensures the CAN traffic is minimised, allowing for the extra traffic during transfer and ensures other devices are not affected.**

 **NOTE: For CAN connection details see section entitled *USB-CAN Interface* elsewhere in this document.**

Connection is by CAN.

#### 4.2.3 DSEM640 & DSEM643

 **NOTE: Ensure no other devices are connected to the CAN during DSEServiceTool operation. This ensures the CAN traffic is minimised, allowing for the extra traffic during transfer and ensures other devices are not affected.**

 **NOTE: DSEM640 / DSEM643 Connection by CAN is supported from V2.0 onwards and requires the device to be configured to use one CAN port for *Download*. For further details see DSE Publication 057-244 DSEM640 & DSEM643 Operator Manual.**

 **NOTE: CAN connection is considerably slower than Ethernet. File transfer by Ethernet is recommended where possible.**

 **NOTE: For CAN connection details see section entitled *USB-CAN Interface* elsewhere in this document.**

Connection is by Ethernet or CAN.

To enter bootloader mode:

- Remove ECU Power from the device.
- Apply PROGRAM ENABLE PIN (Pin A6).
- Apply ECU Power.
- Device LED illuminates YELLOW to show bootloader mode is active.
- The device is now in the correct state and is *discoverable* by the DSEServiceTool Scan function.
- After completing file transfer, ensure to remove PROGRAM ENABLE to allow bootloader mode to exit.

#### 4.2.4 DSEM835

**NOTE:** Ensure no other devices are connected to the CAN during DSEServiceTool operation. This ensures the CAN traffic is minimised, allowing for the extra traffic during transfer and ensures other devices are not affected.



**NOTE:** For CAN connection details and/or Batch Programming details, see section entitled *USB-CAN Interface* elsewhere in this document.

**NOTE:** Batch programming feature is available only for DSEM835 with Bootloader V1.1.0 onwards. Devices with earlier Bootloader versions cannot be field updated to a later Bootloader version. DSEServiceTool V1.46.3 or later is required. DSEM835 devices with serial number 8958811 and higher are capable of being batch programmed.

##### 4.2.4.1 CONNECTION FROM PC TO A SINGLE DSEM835 DEVICE

Connection is by CAN.

To enter bootloader mode:

- Remove DC Power from DSEM835.
- Right-Click  (CODESYS Gateway) in the Windows System Tray. Select *Stop Gateway*. This disconnects CODESYS from the PCAN USB driver for use with DSEServiceTool.
- Connect DSEM835 to the PCAN interface.
- Click  on the DSEServiceTool underneath *Select Connection Method*.
- Apply DC Power to DSEM835.
- DSEM835 displays confirmation of bootloader mode (Version number may differ. ID is shown only for Bootloader V1.1.0 onwards)

**M835 BOOTLOADER V1.1.0**  
**Download ID 1**

- Upon completion of using DSEServiceTool to service the DSEM835, Close DSEServiceTool, Right-Click  (CODESYS Gateway) in the Windows System Tray. Select *Start Gateway*. This reconnects CODESYS to the PCAN USB driver.

For Connection from PC to Multiple DSEM835 devices, see overleaf.

#### 4.2.4.2 CONNECTION FROM PC TO MULTIPLE DSEM835 DEVICES



**NOTE:** Ensure no other devices are connected to the CAN during DSEServiceTool operation. This ensures the CAN traffic is minimised, allowing for the extra traffic during transfer and ensures other devices are not affected.

**NOTE:** For CAN connection details and/or Batch Programming details, see section entitled *USB-CAN Interface* elsewhere in this document.

**NOTE:** Batch programming feature is available only for DSEM835 with Bootloader V1.1.0 onwards. Devices with earlier Bootloader versions cannot be field updated to a later Bootloader version. DSEServiceTool V1.46.3 or later is required. DSEM835 devices with serial number 8958811 and higher are capable of being batch programmed.

Connection is by CAN to up to ten (10) DSEM835 devices.

To enter bootloader mode:

- Remove DC Power from all DSEM835s. A single DC power switch is the most suitable way to achieve this.
- Right-Click  (CODESYS Gateway) in the Windows System Tray. Select *Stop Gateway*. This disconnects CODESYS from the PCAN USB driver for use with DSEServiceTool.
- Connect DSEM835s to the Batch Programming harness and in turn connect this to the PCAN USB interface.
- Click  on the DSEServiceTool underneath *Select Connection Method*.
- Apply DC Power to all DSEM835s. A single DC power switch is the most suitable way to achieve this.
- All DSEM835s display confirmation of bootloader mode (Version number may differ. ID differs between devices.)

**M835 BOOTLOADER V1.1.0**  
**Download ID 1**

- Any device not showing the *Bootloader* message was not found in the scan. Check connections and retry the scan, otherwise continue to program all devices that were found, and correctly show the *Bootloader* message.
- Upon completion of using DSEServiceTool to service the DSEM835, Close DSEServiceTool, Right-Click  (CODESYS Gateway) in the Windows System Tray. Select *Start Gateway*. This reconnects CODESYS to the PCAN USB driver.

#### 4.2.5 DSEM840

Connection is by Ethernet.

To enter bootloader mode:

- Remove ECU Power from the device.
- Press and hold any THREE buttons.
- Apply ECU Power.
- Wait until the display enters the Boot Menu and release the three buttons.
- The device is now in the correct state and is *discoverable* by the DSEServiceTool Scan function.

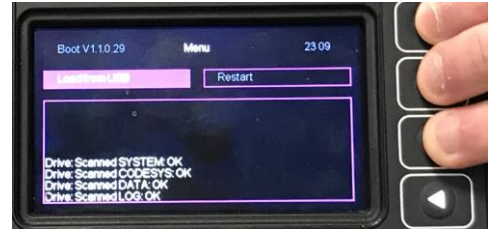



#### 4.2.6 DSEM870 / DSEM871

**NOTE: Only CODESYS Variants are supported by DSEServiceTool PC Software.**

Connection is by Ethernet.

To enter bootloader mode:

- Remove ECU Power from the device.
- Press and hold any THREE buttons.
- Apply ECU Power.
- Wait until the display shows *Entering Flash/Recovery*, Now release the three buttons. The device restarts and enters *Flash/Recovery* mode.

Continued Overleaf.



- The display shows a countdown timer after which the device reboots normally.
- To halt the timer and remain in bootloader mode, press and hold the device rotary encoder button until the timer message disappears.

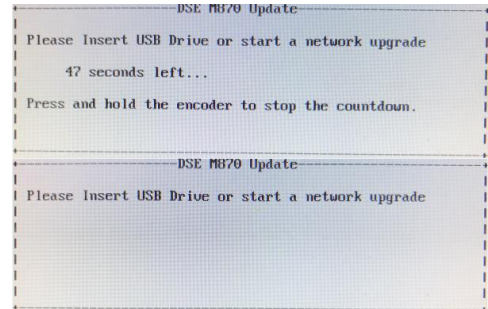

- The device is now in the correct state and is *discoverable* by the DSEServiceTool Scan function.

#### 4.2.7 DSEM812

**NOTE: Only CODESYS Variants are supported by DSEServiceTool PC Software.**

Connection is by Ethernet.

To enter bootloader mode:

- Remove ECU Power from the device.
- Apply *Program Enable Pin* (or press and hold any THREE buttons on M812 variant with buttons)
- Apply ECU Power.
- Wait until the display shows the menu,
- Release the three buttons (if held) and select (press) *Recovery*.
- *Program Enable* pin can now be removed (if applied previously).

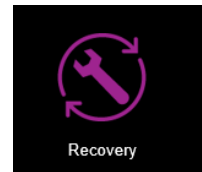

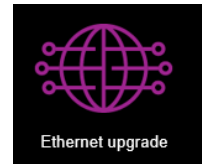

- To halt the timer and remain in bootloader mode, select (press) *Ethernet upgrade*.



- The device is now in the correct state and is *discoverable* by the DSEServiceTool Scan function.

### 4.3 SEARCHING FOR DEVICES

**NOTE:** When connecting by CAN it may be necessary to first stop the CODESYS Gateway: Right-Click  (CODESYS Gateway) in the Windows System Tray and select *Stop Gateway*. This disconnects CODESYS from the PCAN USB driver for use with DSEServiceTool. Upon completion of using DSEServiceTool to service the device, Close DSEServiceTool, Right-Click  (CODESYS Gateway) in the Windows System Tray and select *Start Gateway*. This reconnects CODESYS to the PCAN USB driver.

**NOTE:** Selectable Baud Rate feature is available only for DSEM835 with Bootloader V1.2.0 onwards. For all other versions and for DSEM640 / DSEM643, select 'Auto'.

**NOTE:** Batch programming feature is available only for DSEM835 with Bootloader V1.1.0 onwards. Devices with earlier Bootloader versions cannot be field updated. DSEServiceTool V1.46.3 or later is required.

**NOTE:** Searching for CAN devices takes up to 20 seconds.

**NOTE:** Searching for an Ethernet device can take a few minutes.

To connect with DSEM640, DSEM643 you may select either *Ethernet*, or *CAN* depending upon configuration of the device. Connection by CAN requires prior enabling of the CAN port. For further details, see DSE Publication 057-244 *DSEM640 / DSEM643 Operator Manual*.

To connect with DSEM840, M870 and DSEM812, click *Ethernet* to search the network for devices (connection by CAN is not supported).

To connect with DSEM240. click *CAN* (this device does not include Ethernet connectivity).

To connect with DSEM835, click *CAN* to scan for a single device or up to ten (10) devices connected by the *Batch Programming Harness*.

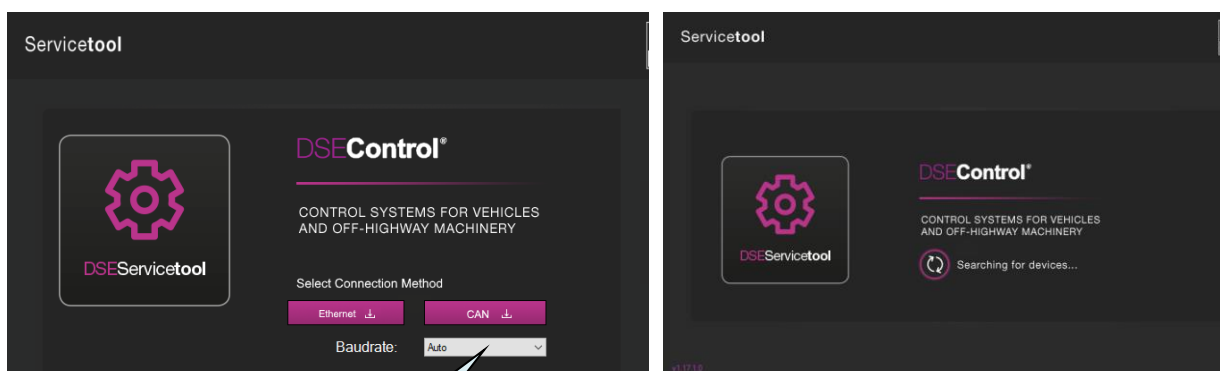

For M835 Bootloader V1.1.0+ you can select the required baud rate. For all other versions and for DSEM640 / DSEM643 you must select 'Auto'.

### 4.3.1 FAILED TO INITIALISE CAN

Before searching for devices, DSEServiceTool initialises the CAN (PCAN USB). In case of error, the following message is shown:

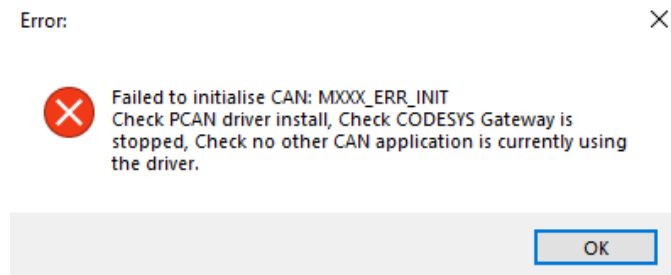

Common causes for this error are:

- PCAN USB Driver is not installed.
- PCAN USB Driver is in use by another program. Ensure CODESYS Gateway is stopped and all other CAN software is closed.

### 4.3.2 NO MODULES FOUND

**NOTE:** For CAN devices, ensure the CAN is correctly connected and termination resistors are fitted. For a single DSEM835, DSE part 016-177 (M835 Programming Harness) includes the termination resistor as this is intended to be the only connection to the DSEM835. DSE part 016-176 M835 Connector Harness DOES NOT include the termination resistor as this may be part of a larger CAN network.

**NOTE:** Batch programming feature is available only for DSEM835 with Bootloader V1.1.0 onwards. Devices with earlier Bootloader versions cannot be field updated to a later Bootloader version. DSEServiceTool V1.46.3 or later is required.

**NOTE:** For Ethernet devices, ensure the device is on the same *subnet* as the PC. For further details consult your IT Network Manager.

When no DSE devices are detected on the network, the DSEServiceTool issues a warning message :

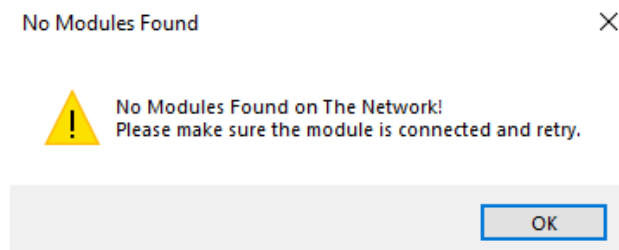

Check connections including cable type and the presence of CAN termination resistors where appropriate, and ensure the device to connect with is in the *Bootloader* mode. After clicking *OK*, click the button to repeat the scan.

### 4.3.3 DEVICES FOUND

#### 4.3.3.1 CAN CONNECTED DEVICES

Where devices are found using CAN, the *Basic* page is automatically displayed. See section entitled *Basic* for further details.

#### 4.3.3.2 ETHERNET CONNECTED DEVICES

When DSE devices are connected to the ethernet network, the DSEServiceTool software displays the type and number of devices detected. To connect, select the required device type. After selection the *Basic* page is automatically displayed. See section entitled *Basic* for further details.

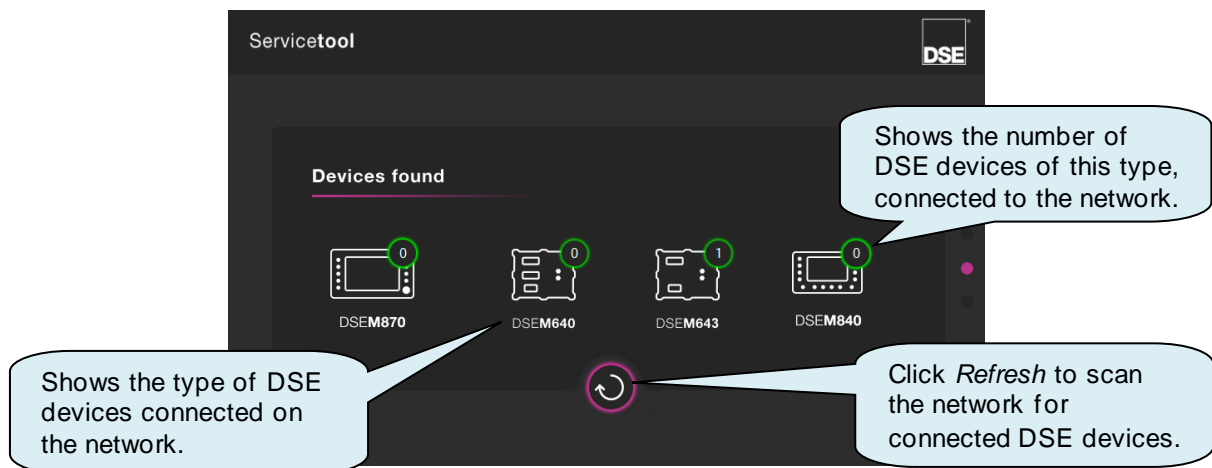

## 4.4 BASIC

**NOTE:** If the transferred file is not suitable for the connected device (ie incorrect firmware version), DSEServiceTool does not warn. Simply the device fails to install the file.

**NOTE:** File transfer is not possible with DSEM870 V1 and V2 devices. The firmware must be updated to ensure full compatibility with DSEServiceTool.

This section shows basic information and allows a package file to be transferred to the DSE device. For other feature, see section entitled *Advanced* elsewhere in this document.

### 4.4.1 DSEM240

**NOTE:** DSEM240 is no longer available and is included here for legacy support only.

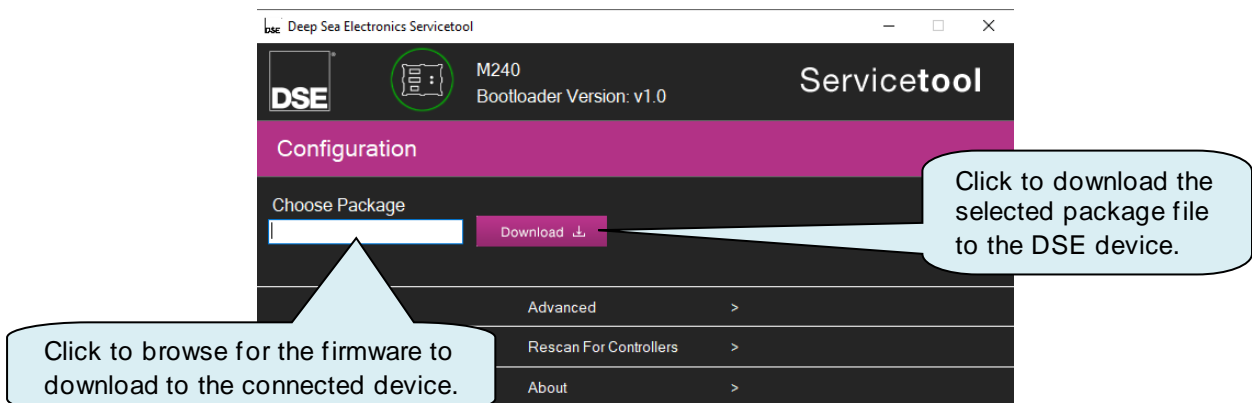

Parameters described overleaf.

#### 4.4.2 DSEM640, DSEM643, DSEM840, DSEM870, DSEM871, & DSEM812

**NOTE:** The boot application must be the same major.minor version as the target device otherwise the device does not apply the file after transfer. Example, CODESYS project with device descriptor V1.0.0.0 results in boot application suitable for device version V1.0.x and package file suitable for device version V1.0.x. Other version (eg V1.1.x) will not apply the file after transfer.

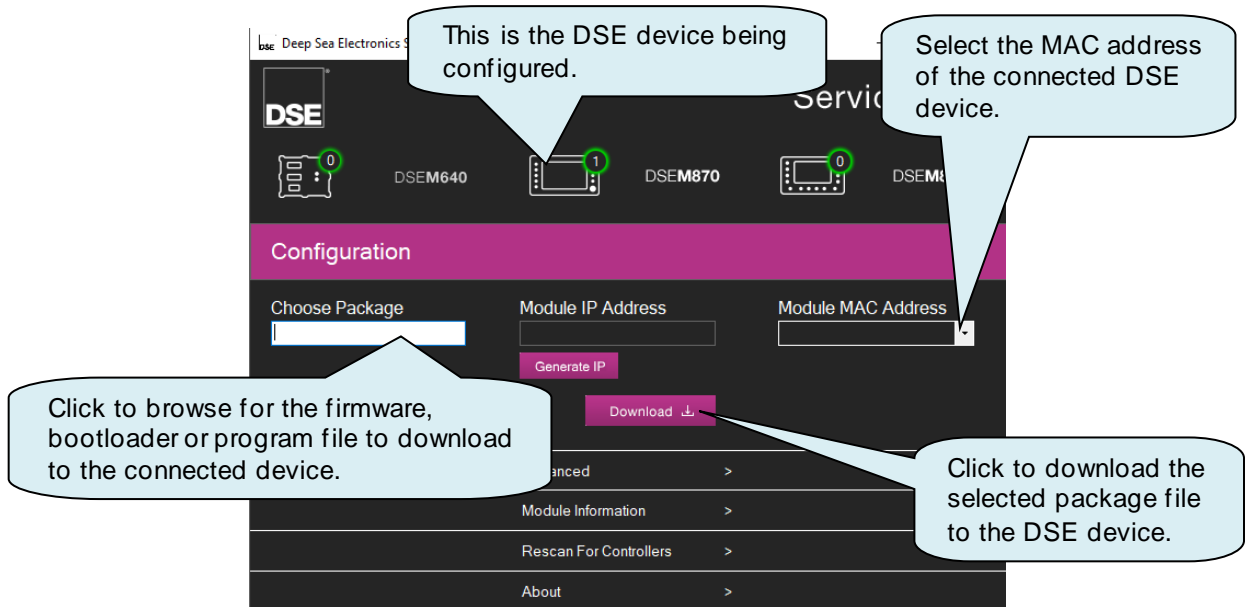

Parameters described overleaf.

### 4.4.3 DSEM835

**NOTE:** The boot application must be the same major.minor version as the target device otherwise the device does not apply the file after transfer. Example, CODESYS project with device descriptor V1.0.0.0 results in boot application suitable for device version V1.0.x and package file suitable for device version V1.0.x. Other version (eg V1.1.x) will not apply the file after transfer.

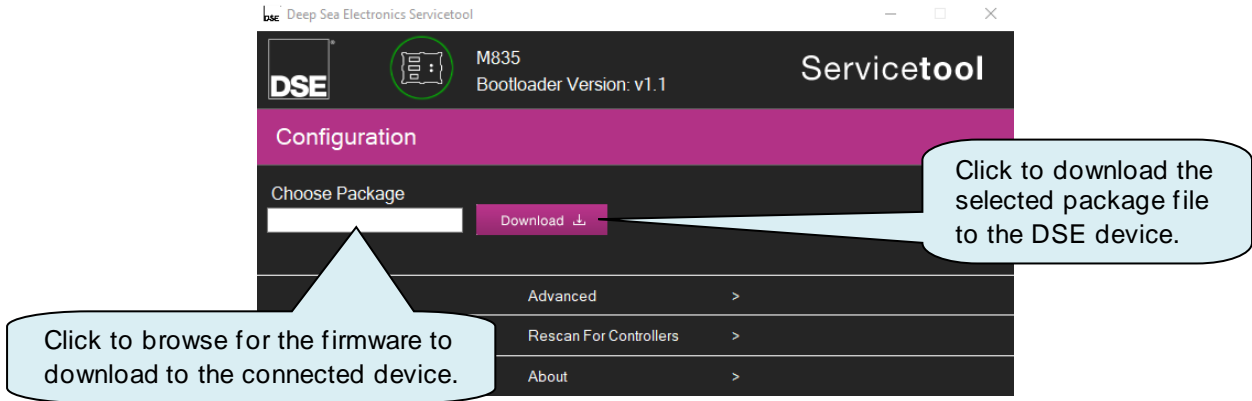

Parameters described below.

### 4.4.4 PARAMETERS

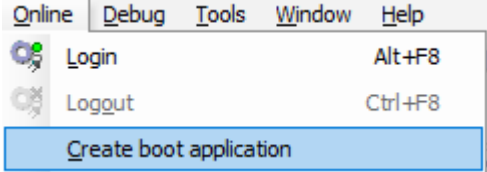
Option	Description
Choose Package	<p>Browse to select the package file to be sent to the device. Compatible packages include bootloader updates (not applicable to DSEM835), firmware updates and application software.</p> <p>To create an application file suitable for transfer (not applicable to DSEM240), from within CODESYS:</p> <ul style="list-style-type: none"> <li>Select <i>Online   Create Boot Application</i> :                      </li> <li>The file is saved with extension <i>.app</i> suitable for sending to the target device from DSEServicetool PC Software. For further details, see the relevant device CODESYS / Operator Manual.</li> </ul>
Module IP Address Generate IP (Not applicable to CAN connections)	<p>This is the address that is used for the transfer process of the package file.</p> <p>If you have already been provided an IP address for the device by the network manager, enter it here, or enter a unique IP address not already in use on the connected network.</p> <p>If an IP address has not yet been assigned, you may click <i>Generate IP</i> to allow DSEServicetool to temporarily assign an IP address to the device. This is used only for the transfer process.</p>
Basic	Provides a simplified display without the <i>Transfer Status</i> window.



<b>Option</b>	<b>Description</b>
Module Information (Not applicable to CAN connections)	Displays the following information about the connected device: <i>MAC Address:</i> <i>UID (Unique Identifier)</i> <i>Firmware Version</i> <i>Bootloader Version</i> <i>Recovery File Version</i>
Rescan for Controllers	Restarts the scan process to look for newly connected devices.
About	Displays version information for DSEServiceTool PC Software.

## 4.5 ADVANCED

**NOTE:** File transfer is not possible with DSEM870 V1 and V2 devices. The firmware must be updated to ensure full compatibility with DSEServiceTool.

**NOTE:** If the transferred file is not suitable for the connected device (ie incorrect firmware version), DSEServiceTool will not warn. Simply the device fails to install the file.

Designed for advanced users, this section shows the status of the connected device and the transfer progress after downloading a package file.

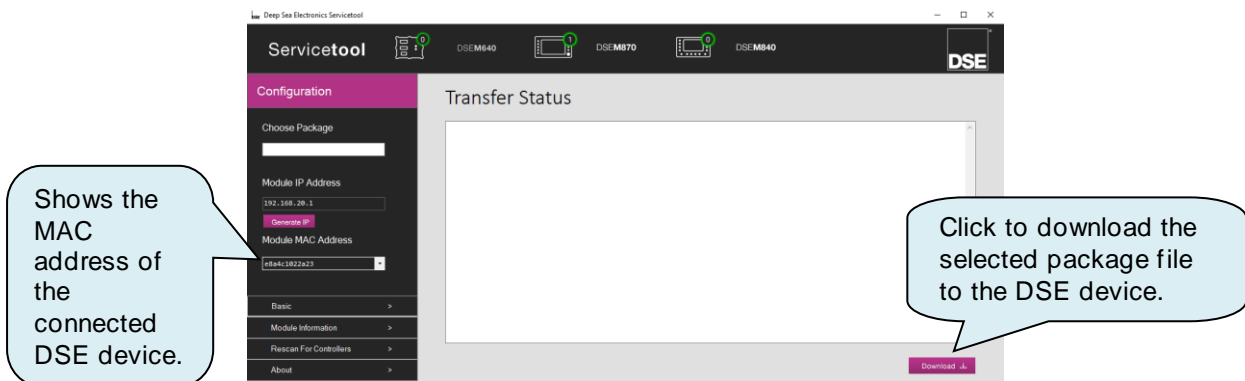

### 4.5.1 PARAMETERS

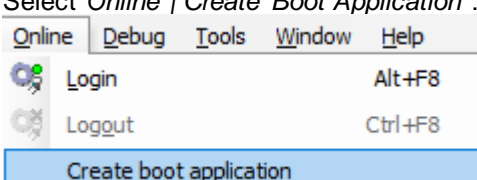
Option	Description
Choose Package	<p>Browse to select the package file to be sent to the device. Compatible packages include bootloader updates (not applicable to DSEM835), firmware updates and application software.</p> <p>To create an application file suitable for transfer (not applicable to DSEM240), from within CODESYS:</p> <ul style="list-style-type: none"> <li>Select <i>Online   Create Boot Application</i> :                      </li> </ul> <p>The file is saved with extension <i>.app</i> suitable for sending to the target device from DSEServiceTool PC Software. For further details, see the relevant device CODESYS / Operator Manual.</p>
Module IP Address Generate IP	<p>This is the address that is used for the transfer process of the package file. If you have already been provided an IP address for the device by the network manager, enter it here, or enter a unique IP address not already in use on the connected network.</p> <p>Alternatively, If an IP address has not yet been assigned, you may click <i>Generate IP</i> to allow DSEServiceTool to temporarily assign an IP address to the device. This address is used only for the transfer process.</p>
Basic	Provides a simplified display without the <i>Transfer Status</i> window.

Option	Description
Module Information	Displays the following information about the connected device: <i>MAC Address</i> <i>UID (Unique Identifier)</i> <i>Firmware Version</i> <i>Bootloader Version</i> <i>Recovery File Version</i>
Rescan for Controllers	Restarts the scan process to look for newly connected devices.
Erase Application (DSEM835 Only)	Removes the CODESYS Application.
Erase Settings (DSEM835 Only)	Erases the non-volatile memory which removes <i>Persistent Variables</i> from the device and sets <i>Device Settings</i> back to factory settings, including CAN baudrate to 250 kbit/s.
About	Displays version information for DSEServiceTool PC Software. When visible, click the window to close it and return to the main program.
Download	Transfers the file to the device. See overleaf for an example image of the <i>Transfer Progress</i> window.

## Using DSEServiceTool PC Software

*Transfer Status* shows file transfer progress at the end of the package download.

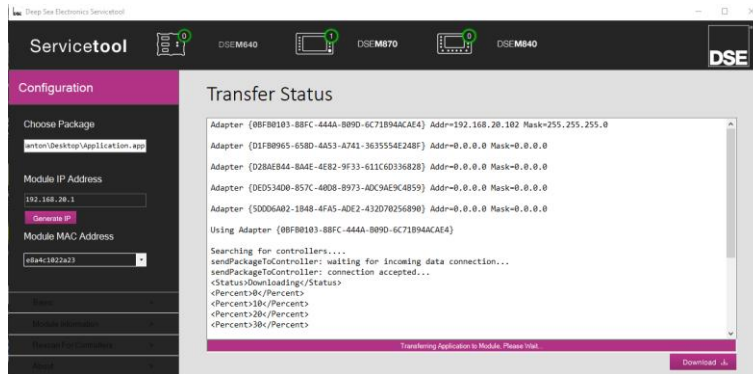

A message is displayed at the end of the package transfer. Power cycling of the module must only be performed after the module's LED turns off.

**NOTE:** If the transferred file is not suitable for the connected device (ie incorrect firmware version), DSEServiceTool will not notify. 'Transfer Successful' is displayed, however the device fails to install the file.

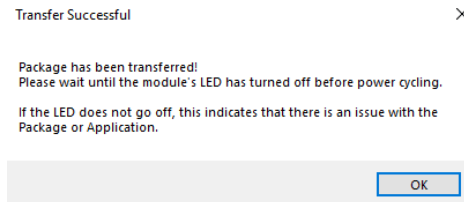

## 4.6 MODULE INFORMATION

This section is designed to show hardware, firmware and bootloader version information of the connected DSE device.

The screenshot shows the 'Servicetool' interface with a sidebar on the left containing a gear icon and 'DSEServicetool' text. The main area displays 'M840 Module' with the following details:

- Mac Address: e8a4c1022b04
- UID: 120346112
- Bootrom: 1.1.19
- Firmware: 1.0.215

Three callout boxes provide explanations:

- The top callout points to the 'Mac Address' field: 'Shows the MAC address of the connected DSE device (Not Applicable to DSEM835).'
- The middle callout points to the 'Bootrom' field: 'Shows the current bootloader version of the connected DSE device.'
- The bottom callout points to the 'Firmware' field: 'Shows the current firmware version of the connected DSE device.'

## 4.7 ABOUT

This section shows the current version of the DSEServicetool PC Software. Click anywhere in the *About* box to remove it and return to the main application.

The 'About' dialog box is displayed on a dark background. It features the 'DSE' logo in the top right corner. The text in the center reads:

Deep Sea Electronics  
Servicetool  
v1.19.1.0

At the bottom, the website address 'www.deepseaelectronics.com' is listed.

## 5 COMMAND LINE CONTROL OF DSESERVICETOOL PC SOFTWARE

**NOTE:** Command Line Control is an advanced feature not intended for normal use. It is a feature provided to help system developers apply a Boot Application file to the device within (for example) an integrated production environment. For regular (normal) use of DSEServiceTool PC Software, see the section entitled *Using DSEServiceTool PC Software*.

**NOTE:** Transfer by CAN is not supported by Command Line Control. Ethernet transfer is supported only.

### 5.1 SUMMARY

1. Create the *Boot Application* from within CODESYS. This is covered in detail within the relevant DSE controller CODESYS Software Manual.
2. Convert the *.app* and associated files to a *.pkg* file as detailed within this document.
3. Transfer the *.pkg* file to the device by ethernet as detailed within this document.

### 5.2 CREATION OF BOOT APPLICATION

**NOTE:** These are generic instructions and images shown may not match the results from a given controller type. Controller specific instructions are provided within the controller's CODESYS Software Manual.

**NOTE:** The boot application includes the folder *PlcLogic*. This contains all images, text files and associated visualisation files. Therefore, these files should be considered as *Company Confidential* to you as they contain some source parts of your application. Convert to *.pkg* file to protect them further.

Within CODESYS select *Online | Create boot application*

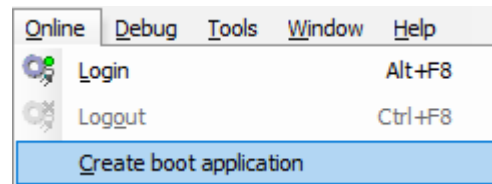

Browse to select the location to store the files. It is convenient to put the files into a new (empty) folder. The example, to the right shows the boot application files in the new folder.

All these files (including the sub folder) make up the boot application and must be kept together.

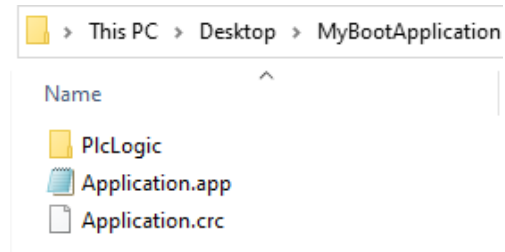

### 5.3 CONVERSION OF .APP TO .PKG

**NOTE:** Example conversion batch (.bat) files are provided. Experienced Windows users can copy/paste and modify them or to include other operations as required. Contact [support@deepseaelectronics.com](mailto:support@deepseaelectronics.com) for assistance if required.

- Note the location of your Boot Application (.app files)
- Open a Windows *Command Prompt* in the DSEServiceTool installation folder:

```
C:\WINDOWS\system32\cmd.exe  
  
C:\Program Files (x86)\Deep Sea Electronics plc\DSEServiceTool>
```

- Convert the file using one of the example converters or create your own using the examples as a template.

```
C:\WINDOWS\system32\cmd.exe  
  
C:\Program Files (x86)\Deep Sea Electronics plc\DSEServiceTool>m840-02Convert.bat <path to folder>
```

Whilst the convert.bat files are configurable, the summary of the batch file functionality is as follows.

**<Boot Application Files>** Used to create .tar which is converted to CODESYS .img  
**<CODESYS .img>** Used to create the object .pkg file which is suitable for transfer to the target device.

1. Copy the relevant *Boot Application* files to a new (temporarily created) folder.
2. Make a .tar archive of the files
3. Make a CODESYS .img file from the .tar file and delete the (no longer required) .tar file.
4. Remove the (no longer required) temporary folder.
5. Create the .pkg file from the .img file and remove the (no longer required) .img file.

## 5.4 ETHERNET TRANSFER OF THE .PKG FILE TO THE TARGET DEVICE

 **NOTE:**The MAC address of the target device ethernet adaptor is found within the System Pages of the relevant device. See device Operator Manual for details.

 **NOTE:** The boot application must be the same major.minor version as the target device otherwise the device does not apply the file after transfer. Example, CODESYS project with device descriptor V1.0.0.0 results in boot application suitable for device version V1.0.x and package file suitable for device version V1.0.x. Other version (eg V1.1.x) will not apply the file after transfer.

Call the executable *DSE Module Handler.exe*, with parameters of:

<Path to *.pkg file*>

<IP Address of the Target Device>

<MAC Address of the Target Device>

 C:\WINDOWS\system32\cmd.exe

```
C:\Program Files (x86)\Deep Sea Electronics plc\DSEServiceTool>DSE Module Handler.exe <Path to package> <IP> <Module Mac address>
```



*This Page is Intentionally Blank*

*This Page is Intentionally Blank*